

inox 304 + ovale inox

La serie "MP" / "LMP" è realizzata in acciaio inox 304 BA (DIN 1.4301) sp.6/10 - 5/10 senza guarnizione.

Il sistema di giunzione è di tipo maschio/ femmina, mentre il sistema di saldatura è longitudinale continuo alTIG o PLASMA.

Il canale da fumo, come il condotto fumario è idoneo per l'evacuazione dei fumi condensati o secchi per funzionamento in pressione negativa.

Idoneo anche per l'evacuazione dei prodotti di ventilazione. La temperatura max di esercizio per funzionamento in N1 è 600° C senza guarnizione.

Ammessi combustibili solidi con funzionamento a secco.

The "MP" / "LMP" series is made of 304 BA stainless steel (DIN 1.4301) thickness 6/10 – 5/10 without gasket.

The joint system is of male / female type, while the welding system is longitudinal continuous toTIG or PLASMA. The connecting flue pipe, such as the flue liner are suitable for the evacuation of condensed or dried smokes for operations under negative pressure. It is also suitable for the evacuation of ventilation products.

The maximum operating temperature for N1 operations is 600°C without gasket. Solid fuels are allowed for dry running.

La série "MP" / "LMP" est réalisée en acier inoxydable 304 BA (DIN 1.4301) épaisseur 6/10 – 5/10 sans joint.

Le système de jonction est de type mâle / femelle et le système de soudage est longitudinal en continu auTIG ou au PLASMA.

Le canal de fumée et même le conduit sont adaptés pour l'évacuation des condensats ou des fumées sèches pour le fonctionnement en pression négative. Ils sont aussi adaptés pour l'évacuation des produits de ventilation.

La température maximale pour un fonctionnement en N1 est de 600°C sans joint.

Les combustibles solides sont admis pour le fonctionnement à sec.

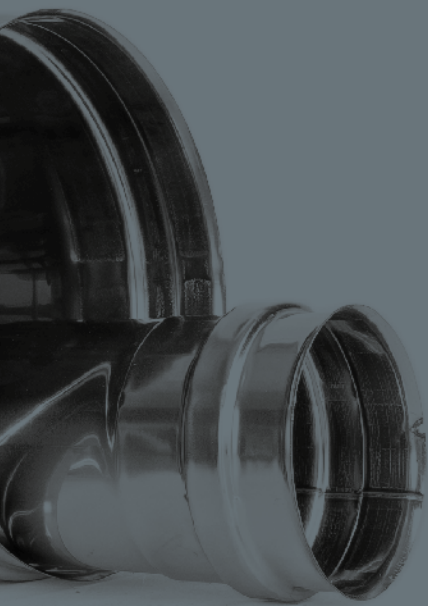

Lunghezza / Length / Longueur: 1000 mm

Cod. / Code / Réf.	N°	Ø
MP130X1000	8	130
MP140X1000	7	140
MP150X1000	5	150
MP160X1000	5	160
MP180X1000	4	180
MP200X1000	6	200
MP220X1000	5	220
MP230X1000	4	230
MP250X1000	6	250
MP300X1000	3	300
MP350X1000	1	350
MP400X1000	1	400
MP450X1000	1	450
MP500X1000	1	500

Lunghezza / Length / Longueur: 500 mm

MP130X500	2	130
MP140X500	2	140
MP150X500	2	150
MP160X500	2	160
MP180X500	2	180
MP200X500	2	200
MP220X500	2	220
MP230X500	2	230
MP250X500	2	250
MP300X500	2	300
MP350X500	1	350
MP400X500	1	400
MP450X500	1	450
MP500X500	1	500

Lunghezza / Length / Longueur: 250 mm

MP130X250	2	130
MP140X250	2	140
MP150X250	2	150
MP160X250	2	160
MP180X250	2	180
MP200X250	2	200
MP220X250	2	220
MP230X250	2	230
MP250X250	2	250
MP300X250	2	300
MP350X250	1	350
MP400X250	1	400
MP450X250	1	450
MP500X250	1	500

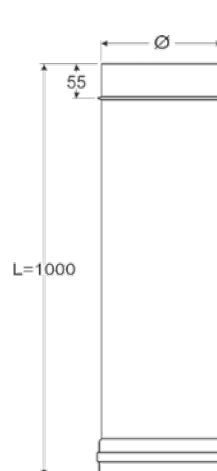

ELEMENTO LINEARE SP. 5/10 - STRAIGHT ELEMENT TH. 5/10 - LONGUEUR DROITE ÉP. 5/10

INOX 304 +
OVALE INOX

Lunghezza / Length / Longueur: 1000 mm

Cod. / Code / Réf.	N°	Ø
LMP80X1000	16	80
LMP100X1000	10	100
LMP120X1000	9	120
LMP130X1000	8	130
LMP140X1000	7	140
LMP150X1000	5	150
LMP160X1000	5	160
LMP180X1000	4	180
LMP200X1000	6	200
LMP220X1000	5	220
LMP230X1000	4	230
LMP250X1000	6	250
LMP300X1000	3	300
LMP350X1000	1	350
LMP400X1000	1	400
LMP450X1000	1	450
LMP500X1000	1	500

Lunghezza / Length / Longueur: 500 mm

LMP80X500	2	80
LMP100X500	2	100
LMP120X500	2	120
LMP130X500	2	130
LMP140X500	2	140
LMP150X500	2	150
LMP160X500	2	160
LMP180X500	2	180
LMP200X500	2	200
LMP220X500	2	220
LMP230X500	2	230
LMP250X500	2	250
LMP300X500	2	300
LMP350X500	1	350
LMP400X500	1	400
LMP450X500	1	450
LMP500X500	1	500

Lunghezza / Length / Longueur: 250 mm

LMP80X250	2	80
LMP100X250	2	100
LMP120X250	2	120
LMP130X250	2	130
LMP140X250	2	140
LMP150X250	2	150
LMP160X250	2	160
LMP180X250	2	180
LMP200X250	2	200
LMP220X250	2	220
LMP230X250	2	230
LMP250X250	2	250
LMP300X250	2	300
LMP350X250	1	350
LMP400X250	1	400
LMP450X250	1	450
LMP500X250	1	500

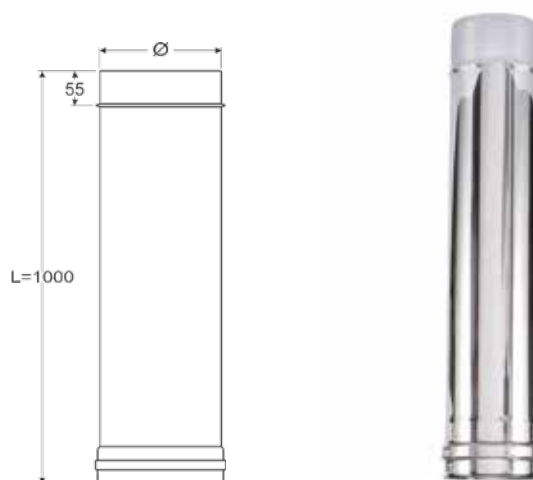

ELEMENTO TELESCOPICO - ADJUSTABLE PIPE - LONGUEUR DROITE AJUSTABLE

Cod. / Code / Réf.	Ø
MPTM560/80	80
MPTM560/100	100
MPTM560/120	120
MPTM560/130	130
MPTM560/140	140
MPTM560/150	150
MPTM560/160	160
MPTM560/180	180
MPTM560/200	200
MPTM560/220	220
MPTM560/230	230
MPTM560/250	250
MPTM560/300	300
MPTM560/350	350

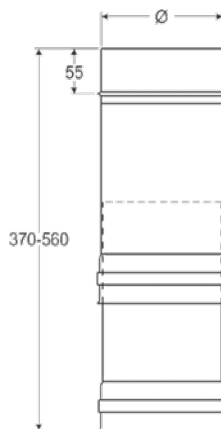

Diametri maggiori su richiesta - Bigger diameters upon request - Diamètres plus grands sur demande

CURVA 30° SP. 6/10 - 30° ELBOWTH. 6/10 - COUDE À 30° ÉP. 6/10

Cod. / Code / Réf.	N°	Ø	H	H1	H2	D	D1	N° SET
MPC130/30	2	130	143	208	303	47	66	2
MPC140/30	2	140	140	210	302	47	66	2
MPC150/30	2	150	142	217	311	48	69	2
MPC160/30	2	160	141	221	314	48	69	2
MPC180/30	2	180	141	231	324	50	72	2
MPC200/30	2	200	162	262	377	57	86	2
MPC220/30	2	220	142	252	346	53	78	2
MPC230/30	2	230	136	251	340	53	76	2
MPC250/30	2	250	150	275	378	57	86	2
MPC300/30	2	300	139	289	380	57	87	2
MPC350/30	1	350	144	319	415	62	96	2
MPC400/30	1	400	142	342	436	65	102	2
MPC450/30	1	450	142	367	461	68	109	2
MPC500/30	1	500	149	399	501	73	119	2

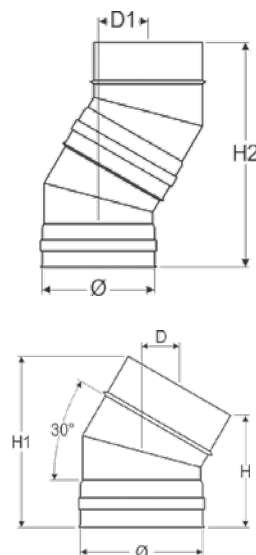

CURVA 30° SP. 5/10 - 30° ELBOWTH. 5/10 - COUDE À 30° ÉP. 5/10

Cod. / Code / Réf.	N°	Ø	H	H1	H2	D	D1	N° SET
LMPC80/30	2	80	138	183	274	43	59	2
LMPC100/30	2	100	140	195	290	45	64	2
LMPC120/30	2	120	137	202	292	46	64	2
LMPC130/30	2	130	143	208	303	47	66	2
LMPC140/30	2	140	140	210	302	47	66	2
LMPC150/30	2	150	142	217	311	48	69	2
LMPC160/30	2	160	141	221	314	48	69	2
LMPC180/30	2	180	141	231	324	50	72	2
LMPC200/30	2	200	162	262	377	57	86	2
LMPC220/30	2	220	142	252	346	53	78	2
LMPC230/30	2	230	136	251	340	53	76	2
LMPC250/30	2	250	150	275	378	57	86	2
LMPC300/30	2	300	139	289	380	57	87	2
LMPC350/30	1	350	144	319	415	62	96	2
LMPC400/30	1	400	142	342	436	65	102	2
LMPC450/30	1	450	142	367	461	68	109	2
LMPC500/30	1	500	149	399	501	73	119	2

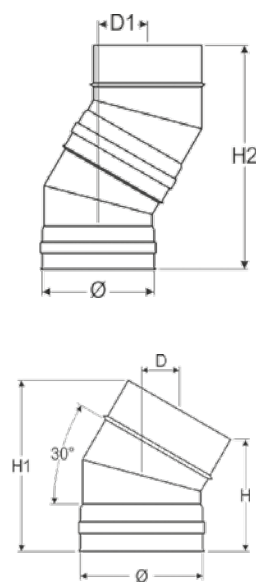

CURVA 45° SP. 6/10 - 45° ELBOWTH. 6/10 - COUDE À 45° ÉP. 6/10

Cod. / Code / Réf.	N°	Ø	H	H1	H2	D	D1	N° SET
MPC130/45	2	130	128	220	309	72	105	2
MPC140/45	2	140	128	227	316	74	108	2
MPC150/45	2	150	132	238	332	77	115	2
MPC160/45	2	160	119	233	313	73	107	2
MPC180/45	2	180	137	264	362	83	127	2
MPC200/45	2	200	131	273	365	84	129	2
MPC220/45	2	220	137	292	390	89	139	2
MPC230/45	2	230	137	299	397	90	142	2
MPC250/45	2	250	130	308	401	91	143	2
MPC300/45	2	300	137	349	446	100	162	2
MPC350/45	1	350	137	384	482	108	177	2
MPC400/45	1	400	133	416	510	114	189	2
MPC450/45	1	450	128	446	535	119	199	2
MPC500/45	1	500	224	577	762	166	293	3

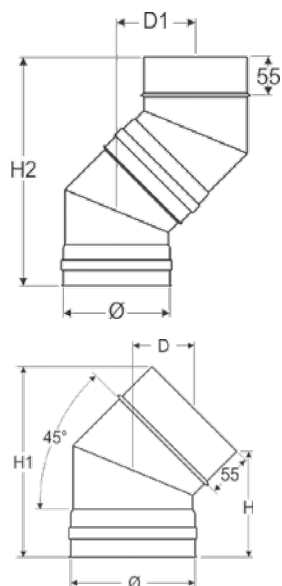

INOX 304 +
OVALE INOX

CURVA 45° SP. 5/10 - 45° ELBOWTH. 5/10 - COUDE À 45° ÉP. 5/10

Cod. / Code / Réf.	N°	Ø	H	H1	H2	D	D1	N° SET
LMPC80/45	2	80	125	189	275	63	91	2
LMPC100/45	2	100	128	206	295	69	99	2
LMPC120/45	2	120	133	225	319	74	109	2
LMPC130/45	2	130	128	220	309	72	105	2
LMPC140/45	2	140	128	227	316	74	108	2
LMPC150/45	2	150	132	238	332	77	115	2
LMPC160/45	2	160	119	233	313	73	107	2
LMPC180/45	2	180	137	264	362	83	127	2
LMPC200/45	2	200	131	273	365	84	129	2
LMPC220/45	2	220	137	292	390	89	139	2
LMPC230/45	2	230	137	299	397	90	142	2
LMPC250/45	2	250	130	308	401	91	143	2
LMPC300/45	2	300	137	349	446	100	162	2
LMPC350/45	1	350	137	384	482	108	177	2
LMPC400/45	1	400	133	416	510	114	189	2
LMPC450/45	1	450	128	446	535	119	199	2
LMPC500/45	1	500	224	577	762	166	293	3

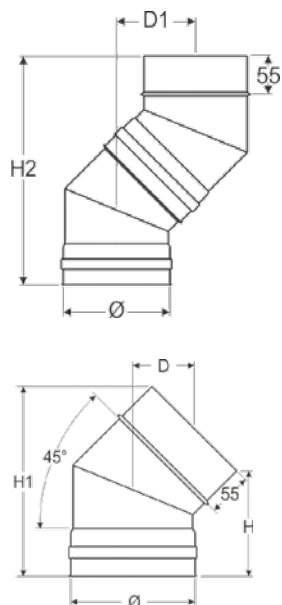

CURVA 90° SP. 6/10 - 90° ELBOWTH. 6/10 - COUDE À 90° ÉP. 6/10

Cod. / Code / Réf.	N°	Ø	H	H1	D	N°SET
MPC130/90	2	130	237	344	289	3
MPC140/90	2	140	236	333	278	3
MPC150/90	2	150	243	337	282	3
MPC160/90	2	160	256	353	298	3
MPC180/90	2	180	269	359	304	3
MPC200/90	2	200	298	396	341	3
MPC220/90	2	220	320	419	364	3
MPC230/90	2	230	322	415	360	3
MPC250/90	2	250	346	443	388	3
MPC300/90	2	300	396	493	438	3
MPC350/90	1	350	461	572	517	4
MPC400/90	1	400	553	706	651	4
MPC450/90	1	450	642	833	778	5
MPC500/90	1	500	715	929	875	5

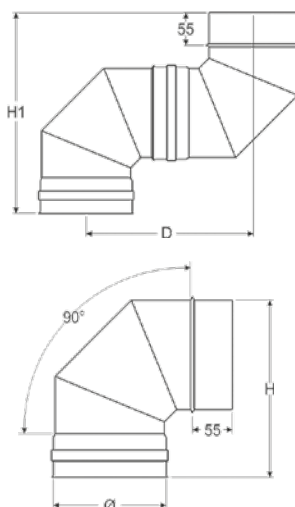

CURVA 90° SP. 5/10 - 90° ELBOWTH. 5/10 - COUDE À 90° ÉP. 5/10

Cod. / Code / Réf.	N°	Ø	H	H1	D	N°SET
LMPC80/90	2	80	156	233	178	3
LMPC100/90	2	100	194	289	234	3
LMPC120/90	2	120	221	323	268	3
LMPC130/90	2	130	237	344	289	3
LMPC140/90	2	140	236	333	278	3
LMPC150/90	2	150	243	337	282	3
LMPC160/90	2	160	256	353	298	3
LMPC180/90	2	180	269	359	304	3
LMPC200/90	2	200	298	396	341	3
LMPC220/90	2	220	320	419	364	3
LMPC230/90	2	230	322	415	360	3
LMPC250/90	2	250	346	443	388	3
LMPC300/90	2	300	396	493	438	3
LMPC350/90	1	350	461	572	517	4
LMPC400/90	1	400	553	706	651	4
LMPC450/90	1	450	642	833	778	5
LMPC500/90	1	500	715	929	875	5

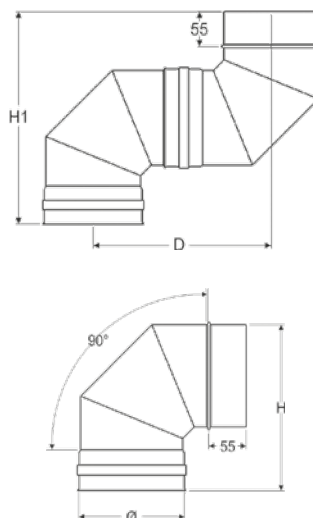

CURVA REGOLABILE SP. 6/10 (DA 0° A 45°) - ADJUSTABLE ELBOWTH. 6/10 (FROM 0° TO 45°) - COUDE ORIENTABLE ÉP. 6/10 (DE 0° À 45°)

Cod. / Code / Réf.	Ø
MPCREG140	140
MPCREG150	150
MPCREG160	160
MPCREG180	180
MPCREG200	200
MPCREG220	220
MPCREG250	250
MPCREG300	300

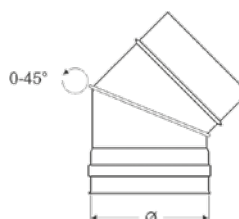

SUPPORTO A MURO - WALL SUPPORT - SUPPORT MURAL

Cod. / Code / Réf.	Ø
MPSMU80	80
MPSMU100	100
MPSMU120	120
MPSMU130	130
MPSMU140	140
MPSMU150	150
MPSMU160	160
MPSMU180	180
MPSMU200	200
MPSMU220	220
MPSMU230	230
MPSMU250	250
MPSMU300	300
MPSMU350	350
MPSMU400	400
MPSMU450	450
MPSMU500	500

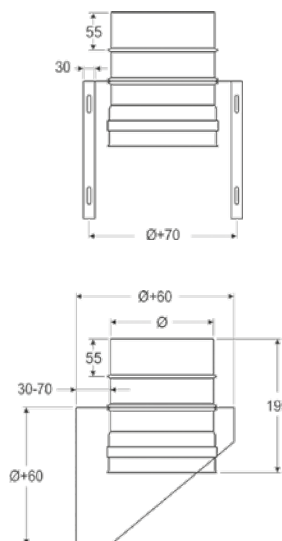

RIDUZIONE-MAGGIORAZIONE - REDUCER-INCREASER - RÉDUCTION-AUGMENTATION

INOX 304 +
OVALE INOX

Cod. Riduz. / Reduc. Code / Réf. Reduc.	Cod. Magg. / Incr. Cod. / Réf. Augm.	ØA	ØB	H
MPR100/80	MPM80/100	100	80	180
MPR120/80	MPM80/120	120	80	180
MPR130/80	MPM80/130	130	80	180
MPR140/80	MPM80/140	140	80	180
MPR150/80	MPM80/150	150	80	180
MPR160/80	MPM80/160	160	80	180
MPR120/100	MPM100/120	120	100	180
MPR130/100	MPM100/130	130	100	180
MPR140/100	MPM100/140	140	100	180
MPR150/100	MPM100/150	150	100	180
MPR160/100	MPM100/160	160	100	180
MPR130/120	MPM120/130	130	120	150
MPR140/120	MPM120/140	140	120	180
MPR150/120	MPM120/150	150	120	180
MPR160/120	MPM120/160	160	120	180
MPR140/130	MPM130/140	140	130	150
MPR150/130	MPM130/150	150	130	180
MPR160/130	MPM130/160	160	130	180
MPR150/140	MPM140/150	150	140	150
MPR160/140	MPM140/160	160	140	180
MPR160/150	MPM150/160	160	150	150
MPR180/150	MPM150/180	180	150	180
MPR200/150	MPM150/200	200	150	180
MPR180/160	MPM160/180	180	160	180
MPR200/160	MPM160/200	200	160	180
MPR200/180	MPM180/200	200	180	180
MPR220/180	MPM180/220	220	180	180
MPR230/180	MPM180/230	230	180	180
MPR250/180	MPM180/250	250	180	180
MPR220/200	MPM200/220	220	200	180
MPR230/200	MPM200/230	230	200	180
MPR250/200	MPM200/250	250	200	180
MPR300/200	MPM200/300	300	200	180
MPR230/220	MPM220/230	230	220	150
MPR250/220	MPM220/250	250	220	180
MPR250/230	MPM230/250	250	230	150
MPR300/230	MPM230/300	300	230	180
MPR300/250	MPM250/300	300	250	180
MPR350/250	MPM250/350	350	250	180
MPR350/300	MPM300/350	350	300	180
MPR400/300	MPM300/400	400	300	180
MPR400/350	MPM350/400	400	350	180
MPR500/400	MPM400/500	500	400	205

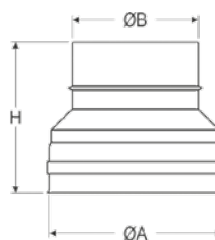
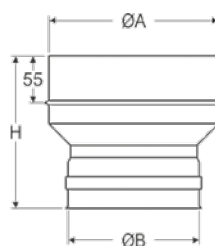

T 90° DERIVAZIONE MASCHIO SP. 6/10 - 90° MALE TEETH. 6/10 - TÉ À 90° MÂLE ÉP. 6/10

Cod. / Code / Réf.	Ø	H	H1	L
MPT130/90M	130	305	150	80
MPT140/90M	140	315	155	80
MPT150/90M	150	315	155	80
MPT160/90M	160	315	155	80
MPT180/90M	180	495	245	80
MPT200/90M	200	495	245	80
MPT220/90M	220	495	245	80
MPT230/90M	230	495	245	80
MPT250/90M	250	495	245	80
MPT300/90M	300	495	245	80

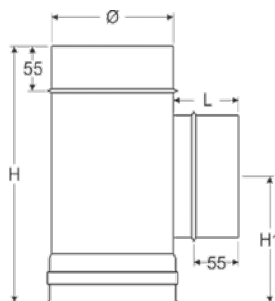

Diametri maggiori su richiesta - Bigger diameters upon request - Diamètres plus grands sur demande

T 90° DERIVAZIONE FEMMINA SP. 6/10 - 90° FEMALE TEETH. 6/10 - TÉ À 90° FEMELLE ÉP. 6/10

Cod. / Code / Réf.	Ø	H	H1	L
MPT130/90F	130	305	150	75
MPT140/90F	140	315	155	75
MPT150/90F	150	315	155	75
MPT160/90F	160	315	155	75
MPT180/90F	180	495	245	75
MPT200/90F	200	495	245	75
MPT220/90F	220	495	245	75
MPT230/90F	230	495	245	75
MPT250/90F	250	495	245	75
MPT300/90F	300	495	245	75

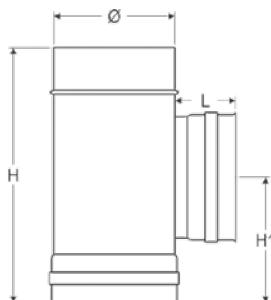

Diametri maggiori su richiesta - Bigger diameters upon request - Diamètres plus grands sur demande

T 90° DERIVAZIONE MASCHIO SP. 5/10 - 90° MALE TEETH. 5/10 - TÉ À 90° MÂLE ÉP. 5/10

Cod. / Code / Réf.	Ø	H	H1	L
LMPT80/90M	80	210	105	80
LMPT100/90M	100	245	120	80
LMPT120/90M	120	305	150	80
LMPT130/90M	130	305	150	80
LMPT140/90M	140	315	155	80
LMPT150/90M	150	315	155	80
LMPT160/90M	160	315	155	80
LMPT180/90M	180	495	245	80
LMPT200/90M	200	495	245	80
LMPT220/90M	220	495	245	80
LMPT230/90M	230	495	245	80
LMPT250/90M	250	495	245	80
LMPT300/90M	300	495	245	80
LMPT350/90M	350	495	245	80
LMPT400/90M	400	595	295	80
LMPT450/90M	450	795	395	85
LMPT500/90M	500	955	475	160

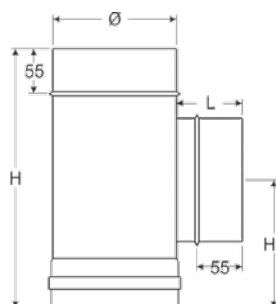

Diametri maggiori su richiesta - Bigger diameters upon request - Diamètres plus grands sur demande

T 90° DERIVAZIONE FEMMINA SP. 5/10 - 90° FEMALE TEETH. 5/10 - TÉ À 90° FEMELLE ÉP. 5/10

Cod. / Code / Réf.	Ø	H	H1	L
LMPT80/90F	80	210	105	75
LMPT100/90F	100	245	120	75
LMPT120/90F	120	305	150	75
LMPT130/90F	130	305	150	75
LMPT140/90F	140	315	155	75
LMPT150/90F	150	315	155	75
LMPT160/90F	160	315	155	75
LMPT180/90F	180	495	245	75
LMPT200/90F	200	495	245	75
LMPT220/90F	220	495	245	75
LMPT230/90F	230	495	245	75
LMPT250/90F	250	495	245	75
LMPT300/90F	300	495	245	75
LMPT350/90F	350	495	245	75
LMPT400/90F	400	595	295	75
LMPT450/90F	450	795	395	80
LMPT500/90F	500	955	475	155



Diametri maggiori su richiesta - Bigger diameters upon request - Diamètres plus grands sur demande

T 135° DERIVAZIONE MASCHIO SP. 6/10 - 135° MALE TEETH. 6/10 - TÉ À 135° MÂLE ÉP. 6/10

Cod. / Code / Réf.	Ø	H	H1	D	DO	HO	DV	HV
MPT130/135M	130	435	116	212	347	417	245	454
MPT140/135M	140	449	119	221	359	434	255	468
MPT150/135M	150	463	123	229	376	453	267	487
MPT160/135M	160	477	127	238	392	472	279	505
MPT180/135M	180	506	134	255	416	506	299	533
MPT200/135M	200	534	141	272	435	538	317	556
MPT220/135M	220	562	148	289	464	574	339	590
MPT230/135M	230	576	151	297	476	591	349	604
MPT250/135M	250	605	158	314	495	623	367	627
MPT300/135M	300	675	176	357	551	707	415	694
MPT350/135M	350	746	194	400	621	796	469	774
MPT400/135M	400	817	211	442	678	880	517	841
MPT450/135M	450	980	218	497	841	1107	617	1106
MPT500/135M	500	980	204	537	898	1153	663	1138

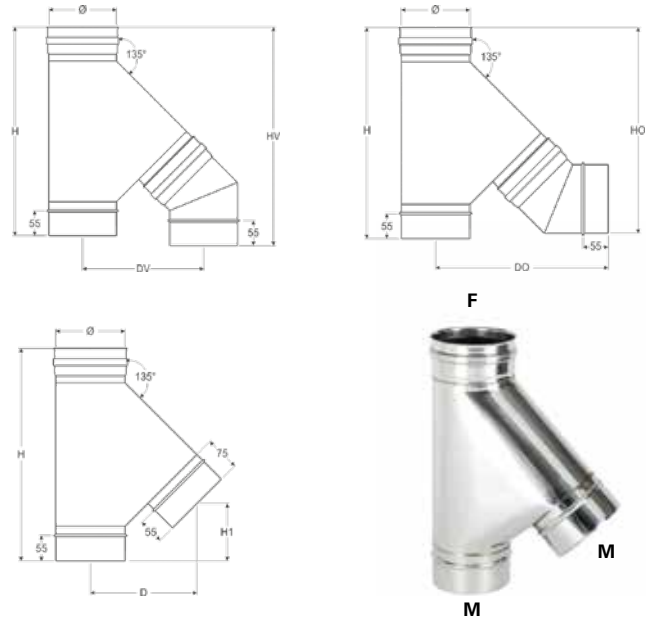

Diametri maggiori su richiesta - Bigger diameters upon request - Diamètres plus grands sur demande

T 135° DERIVAZIONE FEMMINA SP. 6/10 - 135° FEMALE TEETH. 6/10 - TÉ À 135° FEMELLE ÉP. 6/10

Cod. / Code / Réf.	Ø	H	H1	D	DO	HO	DV	HV
MPT130/135F	130	435	120	209	344	414	241	451
MPT140/135F	140	449	123	218	356	431	251	465
MPT150/135F	150	463	127	226	373	450	263	484
MPT160/135F	160	477	131	235	389	469	275	502
MPT180/135F	180	506	138	252	413	503	295	530
MPT200/135F	200	534	145	269	432	535	313	553
MPT220/135F	220	562	148	289	464	574	339	590
MPT230/135F	230	576	155	294	473	588	345	601
MPT250/135F	250	605	162	311	492	620	363	624
MPT300/135F	300	675	180	354	548	704	411	691
MPT350/135F	350	746	198	397	618	793	465	771
MPT400/135F	400	817	215	439	675	877	513	838
MPT450/135F	450	980	218	497	841	1107	617	1106
MPT500/135F	500	980	204	537	898	1153	663	1138

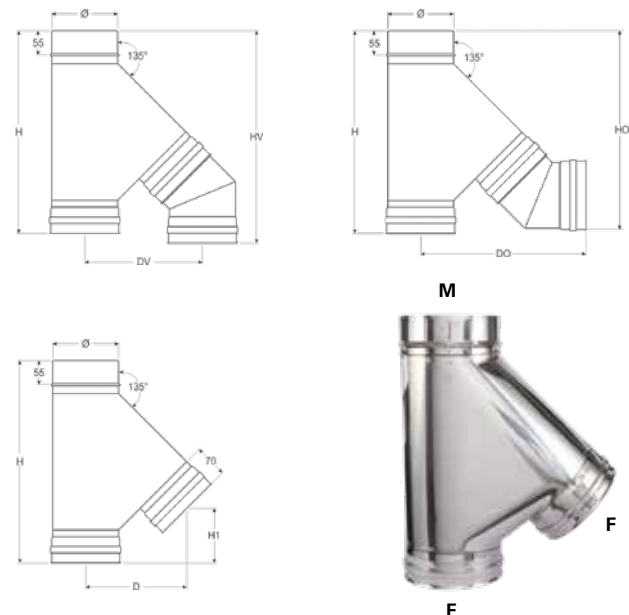

Diametri maggiori su richiesta - Bigger diameters upon request - Diamètres plus grands sur demande

T 135° DERIVAZIONE MASCHIO SP. 5/10 - 135° MALE TEE TH. 5/10 - TÉ À 135° MÂLE ÉP. 5/10

Cod. / Code / Réf.	Ø	H	H1	D	DO	HO	DV	HV
LMPT80/135M	80	365	98	169	288	332	186	384
LMPT100/135M	100	392	110	186	325	373	227	421
LMPT120/135M	120	421	112	203	344	404	239	448
LMPT130/135M	130	435	116	212	347	417	245	454
LMPT140/135M	140	449	119	221	359	434	255	468
LMPT150/135M	150	463	123	229	376	453	267	487
LMPT160/135M	160	477	127	238	392	472	279	505
LMPT180/135M	180	506	134	255	416	506	299	533
LMPT200/135M	200	534	141	272	435	538	317	556
LMPT220/135M	220	562	148	289	464	574	339	590
LMPT230/135M	230	576	151	297	476	591	349	604
LMPT250/135M	250	605	158	314	495	623	367	627
LMPT300/135M	300	675	176	357	551	707	415	694
LMPT350/135M	350	746	194	400	621	796	469	774
LMPT400/135M	400	817	211	442	678	880	517	841
LMPT450/135M	450	980	218	497	841	1107	617	1106
LMPT500/135M	500	980	204	537	898	1153	663	1138

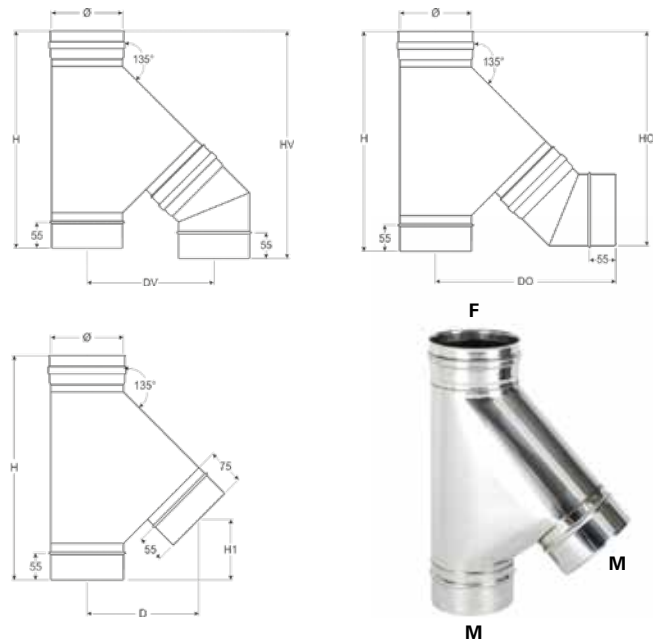

Diametri maggiori su richiesta - Bigger diameters upon request - Diamètres plus grands sur demande

T 135° DERIVAZIONE FEMMINA SP. 5/10 - 135° FEMALE TEE TH. 5/10 - TÉ À 135° FEMELLE ÉP. 5/10

Cod. / Code / Réf.	Ø	H	H1	D	DO	HO	DV	HV
LMPT80/135F	80	365	102	266	285	329	182	381
LMPT100/135F	100	392	114	183	322	370	223	418
LMPT120/135F	120	421	116	200	341	401	235	445
LMPT130/135F	130	435	120	209	344	414	241	451
LMPT140/135F	140	449	123	218	356	431	251	465
LMPT150/135F	150	463	127	226	373	450	263	484
LMPT160/135F	160	477	131	235	389	469	275	502
LMPT180/135F	180	506	138	252	413	503	295	530
LMPT200/135F	200	534	145	269	432	535	313	553
LMPT220/135F	220	562	148	289	464	574	339	590
LMPT230/135F	230	576	155	294	473	588	345	601
LMPT250/135F	250	605	162	311	492	620	363	624
LMPT300/135F	300	675	180	354	548	704	411	691
LMPT350/135F	350	746	198	397	618	793	465	771
LMPT400/135F	400	817	215	439	675	877	513	838
LMPT450/135F	450	980	218	497	841	1107	617	1106
LMPT500/135F	500	980	204	537	898	1153	663	1138

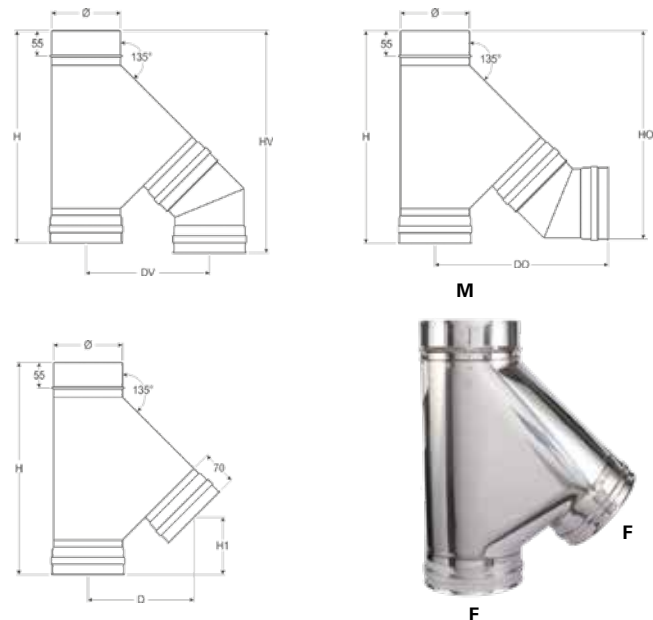

Diametri maggiori su richiesta - Bigger diameters upon request - Diamètres plus grands sur demande

RACCORDO CAMINO-FORNO DERIVAZIONE MASCHIO 135° SP. 6/10 - 135° REDUCING TEE TO Ø 140 MALE TH. 6/10 - TÉ À 135° REDUIT Ø 140 MÂLE ÉP. 6/10

Cod. / Code / Réf.	ØA	ØB	D
MPCF200-140M	200	140	251
MPCF250-140M	250	140	276

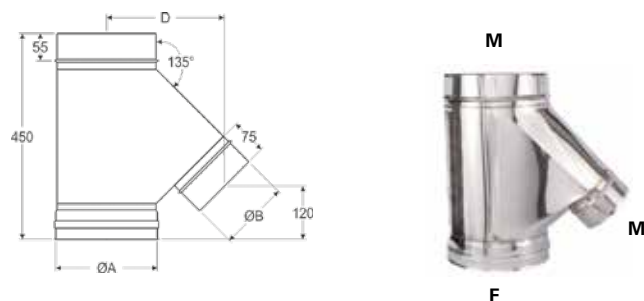

Diametri maggiori su richiesta - Bigger diameters upon request - Diamètres plus grands sur demande

RACCORDO CAMINO-FORNO DERIVAZIONE FEMMINA 135° SP. 6/10 - 135° REDUCINGTEE TO Ø 140 FEMALE TH. 6/10 - TÈ À 135° REDUIT Ø 140 FEMELLE ÉP. 6/10

Cod. / Code / Réf.	ØA	ØB	D
MPCF200-140F	200	140	247
MPCF250-140F	250	140	272

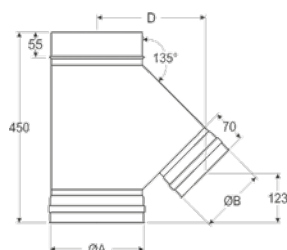

Diametri maggiori su richiesta - Bigger diameters upon request - Diamètres plus grands sur demande

RACCORDO CAMINO-FORNO DERIVAZIONE MASCHIO 135° SP. 5/10 - 135° REDUCINGTEE TO Ø 140 MALE TH. 5/10 - TÈ À 135° REDUIT Ø 140 MÂLE ÉP. 5/10

Cod. / Code / Réf.	ØA	ØB	D
LMPCF200-140M	200	140	251
LMPCF250-140M	250	140	276

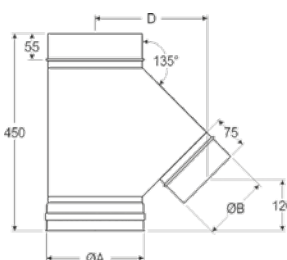

Diametri maggiori su richiesta - Bigger diameters upon request - Diamètres plus grands sur demande

RACCORDO CAMINO-FORNO DERIVAZIONE FEMMINA 135° SP. 5/10 - 135° REDUCINGTEE TO Ø 140 FEMALE TH. 5/10 - TÈ À 135° REDUIT Ø 140 FEMELLE ÉP. 5/10

Cod. / Code / Réf.	ØA	ØB	D
LMPCF200-140F	200	140	247
LMPCF250-140F	250	140	272

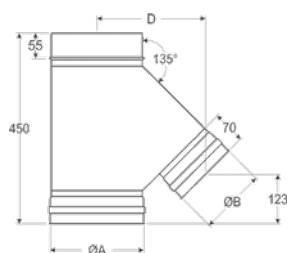

Diametri maggiori su richiesta - Bigger diameters upon request - Diamètres plus grands sur demande

MODULO DI ISPEZIONE CONTAPPO TONDO PER ALTE TEMPERATURE SP. 6/10 - ELEMENT WITH ROUND INSPECTION DOOR FOR HIGH TEMPERATURES TH. 6/10 - ÉLÉMENT AVEC TRAPPE DE VISITE RONDE POUR HAUTES TEMPÉRATURES ÉP. 6/10

Cod. / Code / Réf.	Ø	H	Øi
MPISP130/90HT	130	305	130
MPISP140/90HT	140	315	140
MPISP150/90HT	150	315	150
MPISP160/90HT	160	315	160
MPISP180/90HT	180	495	180
MPISP200/90HT	200	495	200
MPISP220/90HT	220	495	200
MPISP230/90HT	230	495	200
MPISP250/90HT	250	495	200
MPISP300/90HT	300	495	250
MPISP350/90HT	350	495	250
MPISP400/90HT	400	495	250

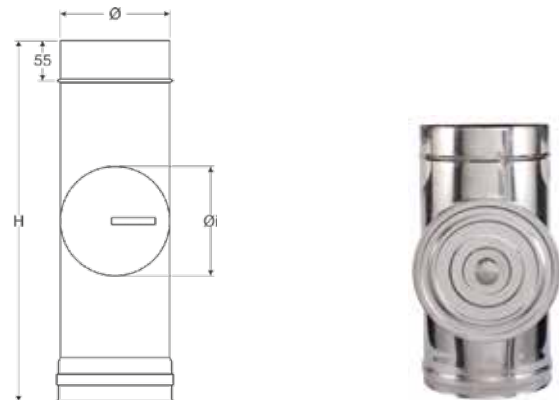

MODULO DI ISPEZIONE CONTAPPO TONDO PER ALTE TEMPERATURE SP. 5/10 - ELEMENT WITH ROUND INSPECTION DOOR FOR HIGH TEMPERATURES TH. 5/10 - ÉLÉMENT AVEC TRAPPE DE VISITE RONDE POUR HAUTES TEMPÉRATURES ÉP. 5/10

Cod. / Code / Réf.	Ø	H	Øi
LMPISP80/90HT	80	210	80
LMPISP100/90HT	100	245	100
LMPISP120/90HT	120	305	120
LMPISP130/90HT	130	305	130
LMPISP140/90HT	140	315	140
LMPISP150/90HT	150	315	150
LMPISP160/90HT	160	315	160
LMPISP180/90HT	180	495	180
LMPISP200/90HT	200	495	200
LMPISP220/90HT	220	495	200
LMPISP230/90HT	230	495	200
LMPISP250/90HT	250	495	200
LMPISP300/90HT	300	495	250
LMPISP350/90HT	350	495	250
LMPISP400/90HT	400	495	250



TUBO CON VALVOLA - PIPE WITH VALVE - TUYAU AVEC VALVE

Cod. / Code / Réf.	Ø
MPV80X250	80
MPV100X250	100
MPV120X250	120
MPV130X250	130
MPV140X250	140
MPV150X250	150
MPV160X250	160
MPV180X250	180
MPV200X250	200
MPV220X250	220
MPV230X250	230
MPV250X250	250
MPV300X250	300
MPV350X250	350

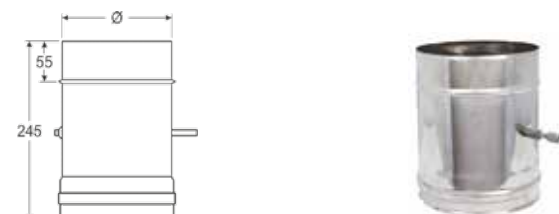

RACCOGLI CONDENSA - DRAIN PLUG - BOUCHON DE CONDENSATION

Cod. Maschio / Male code / Réf. Mâle	Cod. Femmina / Female Code / Réf. Femelle	Ø
MPCON80M	MPGRC80	80
MPCON100M	MPGRC100	100
MPCON120M	MPGRC120	120
MPCON130M	MPGRC130	130
MPCON140M	MPGRC140	140
MPCON150M	MPGRC150	150
MPCON160M	MPGRC160	160
MPCON180M	MPGRC180	180
MPCON200M	MPGRC200	200
MPCON220M	MPGRC220	220
MPCON230M	MPGTM230	230
MPCON250M	MPGRC250	250
MPCON300M	MPGRC300	300
MPCON350M	MPGRC350	350
MPCON400M	MPGRC400	400
MPCON450M	MPGRC450	450
MPCON500M	MPGRC500	500

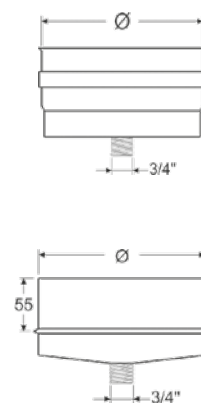

INOX 304 +
OVALE INOX

TAPPO CON MANIGLIA - DRAIN PLUG WITH HANDLE - BOUCHON DE CONDENSATION ÉTANCHE

Cod. Maschio / Male code / Réf. Mâle	Cod. Femmina / Female Code / Réf. Femelle	Ø
MPCON80M	MPGTM80	80
MPCON100M	MPGTM100	100
MPCON120M	MPGTM120	*120
MPCON130M	MPGTM130	*130
MPCON140M	MPGTM140	*140
MPCON150M	MPGTM150	*150
MPCON160M	MPGTM160	160
MPCON180M	MPGTM180	180
MPCON200M	MPGTM200	200
MPCON220M	MPGTM220	220
MPCON230M	MPGTM230	230
MPCON250M	MPGTM250	250
MPCON300M	MPGTM300	300
MPCON350M	MPGTM350	350
MPCON400M	MPGTM400	400
MPCON450M	MPGTM450	450
MPCON500M	MPGTM500	500

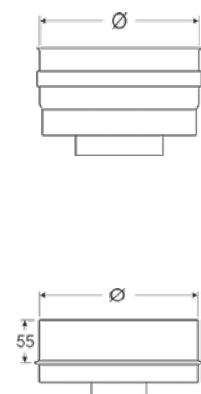

RACCOGLI CONDENSA PER COLLETTORE - LATERAL DRAIN PLUG - BOUCHON DE CONDENSATION AVEC ÉVACUATION LATÉRALE

Cod. Maschio / Male code / Réf. Mâle	Cod. Femmina / Female Code / Réf. Femelle	Ø
MPCONCOL80M	MPCONCOL80F	80
MPCONCOL100M	MPCONCOL100F	100
MPCONCOL120M	MPCONCOL120F	120
MPCONCOL130M	MPCONCOL130F	130
MPCONCOL140M	MPCONCOL140F	140
MPCONCOL150M	MPCONCOL150F	150
MPCONCOL160M	MPCONCOL160F	160
MPCONCOL180M	MPCONCOL180F	180
MPCONCOL200M	MPCONCOL200F	200
MPCONCOL220M	MPCONCOL220F	220
MPCONCOL230M	MPCONCOL230F	230
MPCONCOL250M	MPCONCOL250F	250
MPCONCOL300M	MPCONCOL300F	300
MPCONCOL350M	MPCONCOL350F	350
MPCONCOL400M	MPCONCOL400F	400

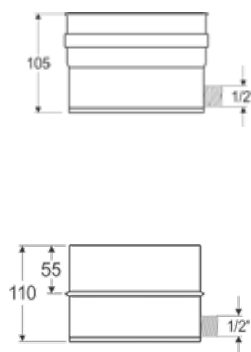

ATTRAVERSAMENTO SOLAIO - INTERMEDIATE ANCHOR PLATE - MODULE DE TRAVERSEMENT DE SOL

Cod. / Code / Réf.	Ø
MPSOL80M	80
MPSOL100M	100
MPSOL120M	120
MPSOL130M	130
MPSOL140M	140
MPSOL150M	150
MPSOL160M	160
MPSOL180M	180
MPSOL200M	200
MPSOL220M	220
MPSOL230M	230
MPSOL250M	250
MPSOL300M	300
MPSOL350M	350

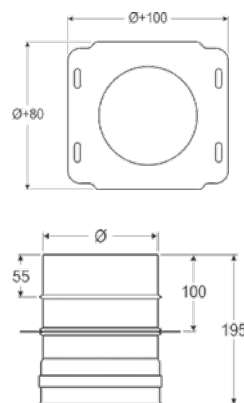

ADATTATORE QUADRO/TONDO MASCHIO - MALE SQUARE TO ROUND ADAPTER - ADAPTATEUR CARRÉ À ROND MÂLE

Cod. / Code / Réf.	A	B
MPAD200X200A...	200	200
MPAD230X230A...	230	230
MPAD250X250A...	250	250
MPAD300X300A...	300	300
MPAD350X350A...	350	350
MPAD400X400A...	400	400

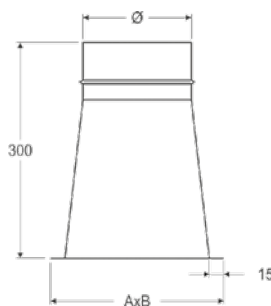

Per completare il codice aggiungere il diametro - To complete the code add diameter size - Pour compléter la référence ajouter le diamètre (MPAD200X200A180)
Su richiesta attacco femmina e misure differenti - Female and custom sizes upon request - Version femelle et mesures différentes sur demande

TRONCHETTO - COUPLER - MANCHETTE

Cod.M-M / M-M Code / Réf. M-M	Cod.F-F / F-F Code / Réf. F-F	Ø
MPTM80	MPTF80	80
MPTM100	MPTF100	100
MPTM120	MPTF120	120
MPTM130	MPTF130	130
MPTM140	MPTF140	140
MPTM150	MPTF150	150
MPTM160	MPTF160	160
MPTM180	MPTF180	180
MPTM200	MPTF200	200
MPTM220	MPTF220	220
MPTM230	MPTF230	230
MPTM250	MPTF250	250
MPTM300	MPTF300	300
MPTM350	MPTF350	350
MPTM400	MPTF400	400
MPTM450	MPTF450	450
MPTM500	MPTF500	500

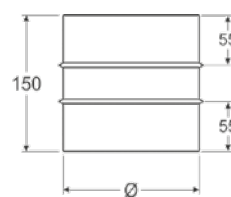
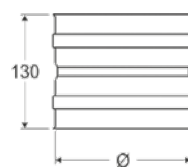

COMIGNOLO CINESE - CHINESE CAP - CHAPEAU CHINOIS

Cod. Maschio / Male code / Réf. Mâle	Cod. Femmina / Female code / Réf. Femelle	Ø	H	A	He
MPGCIN80	MPCIN80	80	185	180	50
MPGCIN100	MPCIN100	100	205	230	70
MPGCIN120	MPCIN120	120	205	265	70
MPGCIN130	MPCIN130	130	205	265	70
MPGCIN140	MPCIN140	140	210	265	75
MPGCIN150	MPCIN150	150	210	265	75
MPGCIN160	MPCIN160	160	215	265	80
MPGCIN180	MPCIN180	180	225	320	90
MPGCIN200	MPCIN200	200	235	320	100
MPGCIN220	MPCIN220	220	250	400	115
MPGCIN230	MPCIN230	230	250	400	115
MPGCIN250	MPCIN250	250	260	400	125
MPGCIN300	MPCIN300	300	285	500	150
MPGCIN350	MPCIN350	350	310	600	175
MPGCIN400	MPCIN400	400	340	600	200
MPGCIN450	MPCIN450	450	260	630	100
MPGCIN500	MPCIN500	500	260	680	100

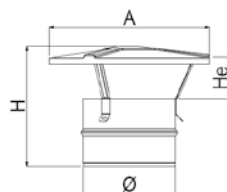

INOX 304 +
OVALE INOX

COMIGNOLO ANTIVENTO - WINDPROOF CAP - CHAPEAU ANTI-INTEMPÉRIE

Cod. Maschio / Male code / Réf. Mâle	Cod. Femmina / Female code / Réf. Femelle	Ø	H	A	Hf
MPGANT80	MPAV80	80	240	185	165
MPGANT100	MPAV100	100	240	185	165
MPGANT120	MPAV120	120	240	220	165
MPGANT130	MPAV130	130	240	220	165
MPGANT140	MPAV140	140	260	260	200
MPGANT150	MPAV150	150	260	260	200
MPGANT160	MPAV160	160	280	260	200
MPGANT180	MPAV180	180	280	300	200
MPGANT200	MPAV200	200	320	310	250
MPGANT220	MPAV220	220	340	370	250
MPGANT250	MPAV250	250	340	420	250
MPGANT300	MPAV300	300	400	470	310
MPGANT350	MPAV350	350	400	530	310
MPGANT400	MPAV400	400	400	610	310
MPGANT450	MPAV450	450	400	650	310
MPGANT500	MPAV500	500	400	700	310

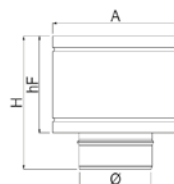

COMIGNOLO TORRINO - TOWER CAP - CHAPEAU DONJON

Cod. Maschio / Male code / Réf. Mâle	Cod. Femmina / Female code / Réf. Femelle	Ø	H	N° CONI
MPGTOR80	MPTOR80	80	330	3
MPGTOR100	MPTOR100	100	330	3
MPGTOR120	MPTOR120	120	330	3
MPGTOR130	MPTOR130	130	330	3
MPGTOR140	MPTOR140	140	330	3
MPGTOR150	MPTOR150	150	330	3
MPGTOR160	MPTOR160	160	330	3
MPGTOR180	MPTOR180	180	390	4
MPGTOR200	MPTOR200	200	390	4
MPGTOR220	MPTOR220	220	390	4
MPGTOR230	MPTOR230	230	390	4
MPGTOR250	MPTOR250	250	390	4
MPGTOR300	MPTOR300	300	450	5
MPGTOR350	MPTOR350	350	450	5

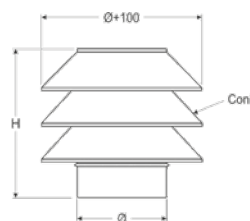

COMIGNOLO EOLICO - AEOLIAN CAP - CHAPEAU ÉOLIEN

Cod. Femmina / Female code / Réf. Femelle	Ø
E080I	80
E0100I	100
E0120I	120
E0130I	130
E0140I	140
E0150I	150
E0160I	160
E0180I	180
E0200I	200
E0220I	220
E0230I	230
E0250I	250
E0300I	300
E0350I	350

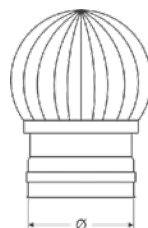

**STAFFA DI FISSAGGIO A PARETE REGOLABILE DA 10 A 150MM - ADJUSTABLE WALL BRACKET FROM 10 TO 150MM -
COLLIER DE FIXATION MURAL RÉGLABLE DE 10 À 150MM**

Cod. / Code / Réf.	Ø	A	B
MPSREG80	80	129	78
MPSREG100	100	149	94
MPSREG120	120	163	103
MPSREG130	130	180	117
MPSREG140	140	200	118
MPSREG150	150	200	134
MPSREG160	160	210	135
MPSREG180	180	230	170
MPSREG200	200	250	179
MPSREG220	220	270	206
MPSREG230	230	280	195
MPSREG250	250	300	175
MPSREG300	300	350	245
MPSREG350	350	400	320
MPSREG400	400	450	376
MPSREG450	450	500	424
MPSREG500	500	550	427

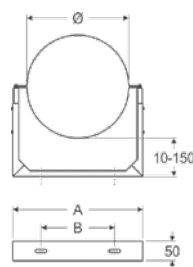

**STAFFA DI FISSAGGIO A PARETE REGOLABILE DA 50 A 80MM - ADJUSTABLE WALL BRACKET FROM 50 TO 80MM -
COLLIER DE FIXATION MURAL RÉGLABLE DE 50 À 80MM**

Cod. / Code / Réf.	Ø	A	B	D
MPS80	80	107	65	50-80
MPS100	100	114	67	50-80
MPS120	120	128	68	50-80
MPS130	130	130	70	50-80
MPS140	140	145	85	50-80
MPS150	150	148	86	50-80
MPS160	160	154	95	50-80
MPS180	180	172	110	50-80
MPS200	200	185	121	50-80
MPS220	220	205	129	50-80
MPS230	230	205	129	50-80
MPS250	250	220	155	50-80
MPS300	300	253	190	50-80
MPS350	350	290	228	50-80
MPS400	400	330	230	50-80
MPS450	450	360	296	50-80
MPS500	500	400	285	50

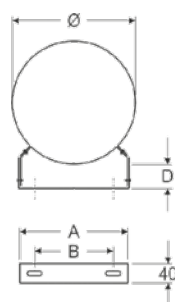

STAFFA DI FISSAGGIO A PARETE CON TASSELLO - WALL BRACKET WITH FISCHER - COLLIER MURAL

INOX 304 +
OVALE INOX

Cod. / Code / Réf.	N°	Ø
MPST80	2	80
MPST100	2	100
MPST120	2	120
MPST130	2	130
MPST140	2	140
MPST150	2	150
MPST160	2	160
MPST180	2	180
MPST200	2	200

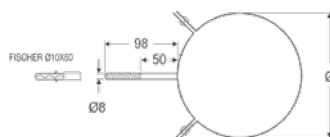

FALDAE PER TETTI INCLINATI CON BASE IN PIOMBO - FLASHING FOR SLOPED ROOFS WITH LEAD BASE - SOLIN DE TOIT PENTU AVEC BASE EN PLOMB

Cod. / Code / Réf.	Ø	ØF	A	B	H
MPFI80	80	110	500	700	180
MPFI100	100	130	500	700	180
MPFI120	120	160	500	700	180
MPFI130	130	160	500	700	180
MPFI140	140	180	500	700	180
MPFI150	150	180	500	700	180
MPFI160	160	180	500	700	180
MPFI180	180	210	700	1000	180
MPFI200	200	230	700	1000	180
MPFI220	220	260	700	1000	180
MPFI250	250	280	700	1000	180
MPFI300	300	330	1000	1000	180
MPFI350	350	380	1000	1000	180
MPFI400	400	430	1000	1000	120

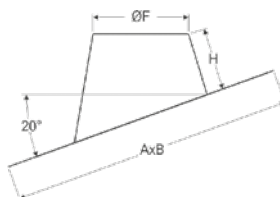

FALDAE PER TETTI PIANI - FLASHING FOR FLAT ROOFS - SOLIN TOITS TERRASSE

Cod. / Code / Réf.	Ø	A	B
MPFP80	80	300	300
MPFP100	100	300	300
MPFP120	120	310	310
MPFP130	130	310	310
MPFP140	140	330	330
MPFP150	150	330	330
MPFP160	160	330	330
MPFP180	180	380	380
MPFP200	200	380	380
MPFP220	220	400	400
MPFP250	250	430	430
MPFP300	300	480	480
MPFP350	350	490	490
MPFP400	400	580	580

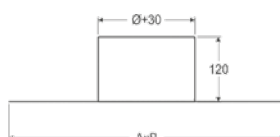

GREMBIULINA DITENUTA - STORM COLLAR - COLLET ANTI-INTEMPÉRIE

Cod. / Code / Réf.	Ø
MPGRE80	80
MPGRE100	100
MPGRE120	120
MPGRE130	130
MPGRE140	140
MPGRE150	150
MPGRE160	160
MPGRE180	180
MPGRE200	200
MPGRE220	220
MPGRE230	230
MPGRE250	250
MPGRE300	300
MPGRE350	350
MPGRE400	400
MPGRE450	450
MPGRE500	500

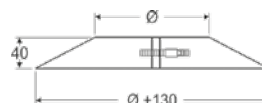

FASCETTA STRINGITUBO - CLAMP - COLLIER DE JONCTION SIMPLE

Cod. / Code / Réf.	Ø
MPFASC80	80
MPFASC100	100
MPFASC120	120
MPFASC130	130
MPFASC140	140
MPFASC150	150
MPFASC160	160
MPFASC180	180
MPFASC200	200
MPFASC220	220
MPFASC230	230
MPFASC250	250
MPFASC300	300
MPFASC350	350
MPFASC400	400
MPFASC450	450
MPFASC500	500

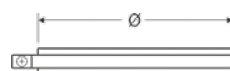

PROLUNGA PER MPS - MPS EXTENSION - RALLONGE POUR MPS

Cod. / Code / Réf.	L
PROLMPS105I	105mm
PROLMPS205I	205mm

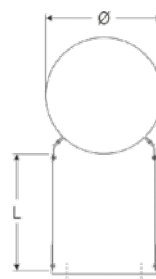

CANNE FUMARIE OVALI - OVAL FLUES - CONDUITS DE FUMÉE OVALES

ELEMENTO LINEARE - STRAIGHT ELEMENT - LONGUEUR DROITE

DISPONIBILE IN 316L (CON AUMENTO 15%) - AVAILABLE IN 316L (INCREASED BY 15%) - DISPONIBILE EN 316L (AUGMENTÉ DE 15%)

INOX 304 +
OVALE INOX

Lunghezza / Length / Longueur: 1000 mm

Cod. / Code / Réf.	A	B
CFOI13X18X1000	130	180
CFOI13X27X1000	130	270
CFOI15X25X1000	150	250
CFOI15X30X1000	150	300
CFOI17X23X1000	170	230
CFOI17X27X1000	170	270
CFOI17X37X1000	170	370
CFOI20X30X1000	200	300

Lunghezza / Length / Longueur: 500 mm

CFOI13X18X500	130	180
CFOI13X27X500	130	270
CFOI15X25X500	150	250
CFOI15X30X500	150	300
CFOI17X23X500	170	230
CFOI17X27X500	170	270
CFOI17X37X500	170	370
CFOI20X30X500	200	300

Lunghezza 1000 su misura - Custom length 1000 - Longueur 1000 sur mesure: € 121,80

Lunghezza 500 su misura - Custom length 500 - Longueur 500 sur mesure: € 69,30

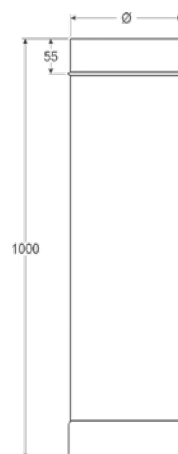

CURVA TIPO 1 - TYPE 1 ELBOW - COUDE TYPE 1

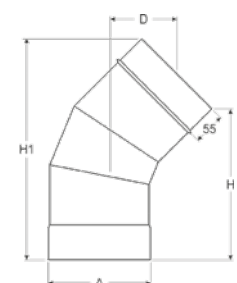
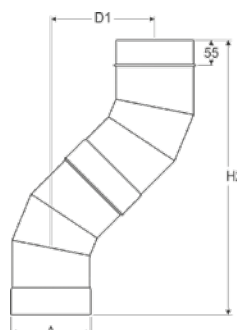

Cod. / Code / Réf.	A	B	H	H1	H2	D	D1
CUROVI13X18/1	130	180	247	339	547	121	204
CUROVI13X27/1	130	270	247	339	547	121	204
CUROVI15X25/1	150	250	247	353	560	124	208
CUROVI15X30/1	150	300	247	353	560	124	208
CUROVI17X23/1	170	230	247	367	576	127	216
CUROVI17X27/1	170	270	247	367	576	127	216
CUROVI17X37/1	170	370	247	367	576	127	216
CUROVI20X30/1	200	300	247	389	597	132	224

Curva su misura - Custom elbow - Coude sur mesure: € 117,90



CURVA TIPO 2 - TYPE 2 ELBOW - COUDE TYPE 2

Cod. / Code / Réf.	A	B	H	H1	H2	D	D1
CUROVI13X18/2	130	180	247	374	583	129	219
CUROVI13X27/2	130	270	247	438	646	142	245
CUROVI15X25/2	150	250	247	424	632	139	239
CUROVI15X30/2	150	300	247	459	667	146	254
CUROVI17X23/2	170	230	247	410	618	136	247
CUROVI17X27/2	170	270	247	438	646	142	245
CUROVI17X37/2	170	370	247	509	717	157	274
CUROVI20X30/2	200	300	247	459	667	146	254

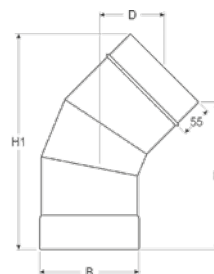
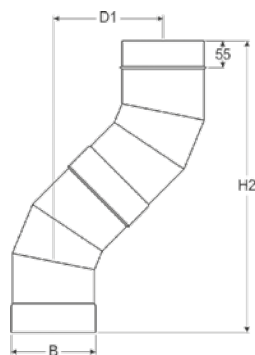

Curva su misura - Custom elbow - Coude sur mesure: € 121,80

ADATTATORE OVALE TONDO FEMMINA - FEMALE OVAL TO ROUND ADAPTER - ADAPTATEUR OVALE À RONDE FEMELLE

Cod. / Code / Réf.	A	B	Ø
ADATI13X18A160MF	130	180	160
ADATI13X27A200MF	130	270	200
ADATI15X25A200MF	150	250	200
ADATI15X30A250MF	150	300	250
ADATI17X23A200MF	170	230	200
ADATI17X27A250MF	170	270	250
ADATI17X37A300MF	170	370	300
ADATI20X30A250MF	200	300	250

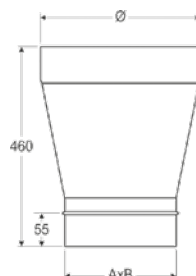

Adattatore su misura - Custom adapter - Adapteur sur mesure: € 110,30

ADATTATORE OVALE TONDO MASCHIO - MALE OVAL TO ROUND ADAPTER - ADAPTATEUR OVALE À RONDE MÂLE

Cod. / Code / Réf.	A	B	Ø
ADATI13X18A160FM	130	180	160
ADATI13X27A200FM	130	270	200
ADATI15X25A200FM	150	250	200
ADATI15X30A250FM	150	300	250
ADATI17X23A200FM	170	230	200
ADATI17X27A250FM	170	270	250
ADATI17X37A300FM	170	370	300
ADATI20X30A250FM	200	300	250

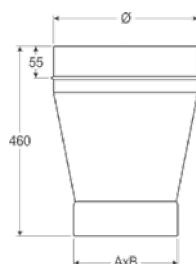

Adattatore su misura - Custom adapter - Adapteur sur mesure: € 110,30

RACCOGLI CONDENSA MASCHIO/FEMMINA - MALE/FEMALE DRAIN PLUG - BOUCHON DE CONDENSATION MÂLE/FEMELLE

INOX 304 +
OVALE INOX

Cod. Maschio / Male code / Réf. Mâle	Cod. Femmina / Female cod. / Femelle Réf.	A	B
MPCON130X180M	MPCON130X180F	130	180
MPCON130X270M	MPCON130X270F	130	270
MPCON150X250M	MPCON150X250F	150	250
MPCON150X300M	MPCON150X300F	150	300
MPCON170X230M	MPCON170X230F	170	230
MPCON170X270M	MPCON170X270F	170	270
MPCON170X370M	MPCON170X370F	170	370
MPCON200X300M	MPCON200X300F	200	300

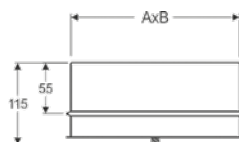

Raccogli condensa su misura - Custom condensate collector - Bouchon de condensation sur mesure: € 118,00

COMIGNOLO CINESE - CHINESE CAP - CHAPEAU CHINOIS

Cod. Maschio / Male code / Réf. Mâle	Cod. Femmina / Female cod. / Femelle Réf.	A	B	Ø
MPCIN130X180M	MPCIN130X180F	130	180	385
MPCIN130X270M	MPCIN130X270F	130	270	435
MPCIN150X250M	MPCIN150X250F	150	250	435
MPCIN150X300M	MPCIN150X300F	150	300	485
MPCIN170X230M	MPCIN170X230F	170	230	435
MPCIN170X270M	MPCIN170X270F	170	270	485
MPCIN170X370M	MPCIN170X370F	170	370	580
MPCIN200X300M	MPCIN200X300F	200	300	485

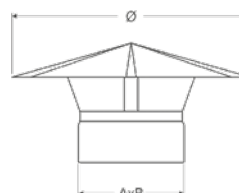

Comignolo cinese su misura - Custom chinese cap - Chapeau chinois sur mesure: € 121,80

COMIGNOLO ANTIVENTO - WINDPROOF CAP - CHAPEAU ANTI-INTEMPÉRIE

Cod. Maschio / Male code / Réf. Mâle	Cod. Femmina / Female cod. / Femelle Réf.	A	B	ØA	ØB
MPAV130X180M	MPAV130X180F	130	180	250	310
MPAV130X270M	MPAV130X270F	130	270	350	390
MPAV150X250M	MPAV150X250F	150	250	320	370
MPAV150X300M	MPAV150X300F	150	300	370	420
MPAV170X230M	MPAV170X230F	170	230	300	360
MPAV170X270M	MPAV170X270F	170	270	350	390
MPAV170X370M	MPAV170X370F	170	370	430	480
MPAV200X300M	MPAV200X300F	200	300	380	420

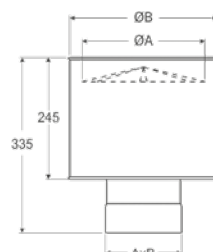

Comignolo antivento su misura - Custom windproof cap - Chapeau anti-vent sur mesure: € 196,40

STAFFA DI FISSAGGIO A PARETE - WALL BRACKET - COLLIER MURAL

Cod. / Code / Réf.	A	B	D
STAFI130X180	130	180	90
STAFI130X270	130	270	140
STAFI150X250	150	250	120
STAFI150X300	150	300	170
STAFI170X230	170	230	100
STAFI170X270	170	270	140
STAFI170X370	170	370	240
STAFI200X300	200	300	170



Staffa a parete su misura - Custom wall bracket - Collier mural sur mesure: € 65,10

FASCETTA - CLAMP - COLLIER DE JONCTION

Cod. / Code / Réf.	A	D
MPFASC130X180	130	180
MPFASC130X270	130	270
MPFASC150X250	150	250
MPFASC150X300	150	300
MPFASC170X230	170	230
MPFASC170X270	170	270
MPFASC170X370	170	370
MPFASC200X300	200	300

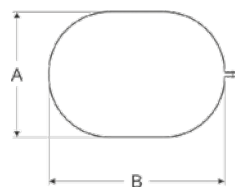

Fascetta su misura non disponibile - Custom clamp not available - Collier de jonction sur mesure pas disponible

